

Classic



Die Kollektion Classic besteht aus Bürostühlen mit hoher Rückenlehne für das Direktionsbüro und Stühlen mit fixen Füßen für Management und Meeting sowie aus Hockern, die sich durch minimalistisches Design und hochwertige Bezüge auszeichnen, mit acht Stoff- und Lederbezügen zur Auswahl, alle in zahlreichen, farblichen Varianten. Das verchromte oder schwarz matt lackierte Stahlgestell wird durch ein fünfstrahliges Fußkreuz in den Ausführungen Aluminium glänzend und Aluminium matt schwarz komplettiert.

Storie collegate

Coca Cola, Kiev, Ukraine (2011)

Credo, Tel Aviv, Israel (2010)

Crédit Lyonnais, Villejuif, Frankreich (2011)

Paroc, Vilnius, Litauen (2012)

NRS Media, Londra, Vereinigtes Königreich (2012)

PTC, Dublino, Irland (2017)

Epsilon, Parigi, Frankreich (2017)

Vittoria Assicurazioni, Catania, Italien (2019)

Bane Nor, Oslo, Norwegen (2019)

FOMO Business and Meetings, Sandnes, Norwegen (2021)

Managerstuhl

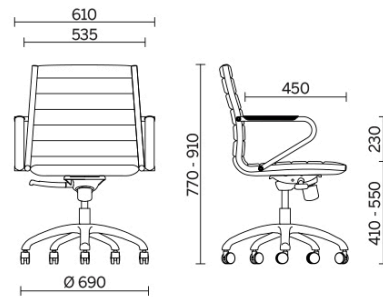

Materiali e rivestimenti

Bezug

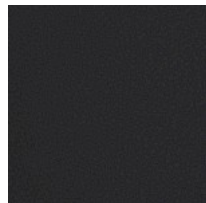

Leder TS - Florida / Dani
Colori disponibili: 12

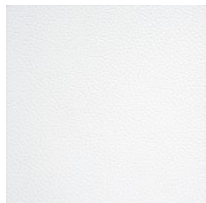

Leder PA - Panama / Dani
Colori disponibili: 13

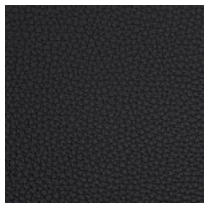

Leder SX + Skai NX
Colori disponibili: 12



Stoff SY - Sinergy / Camira
Colori disponibili: 6

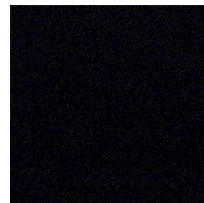

Stoff IP - Ipanema D / Pugi
Colori disponibili: 11



Stoff ME - Medley / Gabriel
Colori disponibili: 13

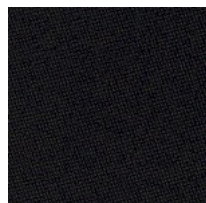

Stoff CH - Chili / Gabriel
Colori disponibili: 13



Stoff CS - Crisp / Gabriel
Colori disponibili: 13

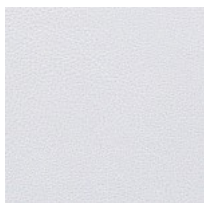

Beschichteter Stoff SC - Secret / Flukso
Colori disponibili: 12

Questo prodotto è garantito 5 anni. Sitland Spa si riserva di apportare modifiche e/o migliorie di carattere tecnico ed estetico ai propri modelli e prodotti in qualsiasi momento e senza preavviso. Le foto e i colori visualizzati sono puramente indicativi e possono variare rispetto alla realtà. Per maggiori informazioni si prega di contattare il nostro Servizio Clienti service@sitland.com