BuzziDish

Product Specification Sheet

This document contains technical information about the BuzziDish



www.buzzi.space







A playful high-performance acoustic solution with rotating capabilities

Playful exterior, complex interior. BuzziDish marries design and function with the recognizable shape, reminiscent of a satellite dish. Featuring a fabric-upholstered body paired with a perforated structure and acoustic foam core interior, BuzziDish's parabolic, concave design efficiently mitigates noise by absorbing undesired sound waves. With a rotating connector, attached to the back of the outside curvature, BuzziDish offers additional functionality and flexibility. Combine an array of panels and turn the body in different directions for added acoustic impact and visual interest—create something never seen before!

Design by Jeffrey Huyghe

General

-  BuzziDish
Wall or Ceiling mounted
-  Upholstered acoustic foam element
Cover: Fabric, Trevira CS+ | CS, Revive 1, Clara 2, Remix 3, Hero 2, Tonus4, Memory 2
-  Dry Use
-  Assembled
-  Bicolor: in same fabric collection

Acoustics



Absorption



Diffusion



Mid tone



High tone

Content

Configurations	3
Components	4
Fabrics	5
Dimensions	8
Acoustics	9

Configuration

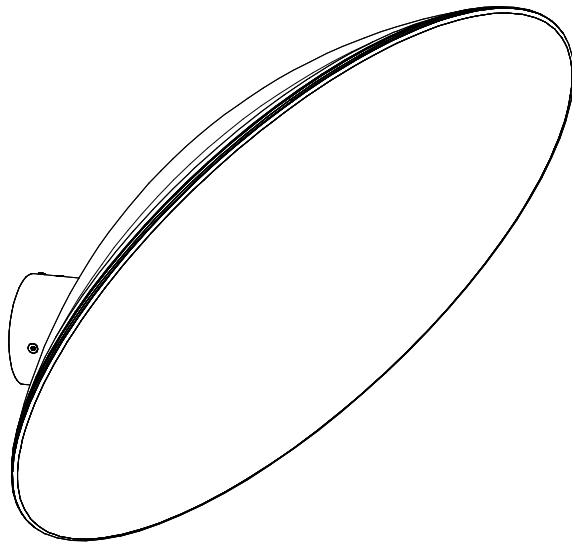

- Wall | Ceiling connection: metal powder coated Black (RAL 9005)
- 🌲 Upholstered acoustic foam element
Cover: Fabric, Trevira CS+ | CS, Revive 1, Clara 2, Remix 3, Hero 2, Tonus4, Memory 2
- ✂️ Ø : 58 cm | 22.83"
H: 15 cm | 5.9"
- ⚖️ 3,1 kg | 6.83 lbs
- ⋯ Bicolor: in same fabric collection

Components

Fixing System

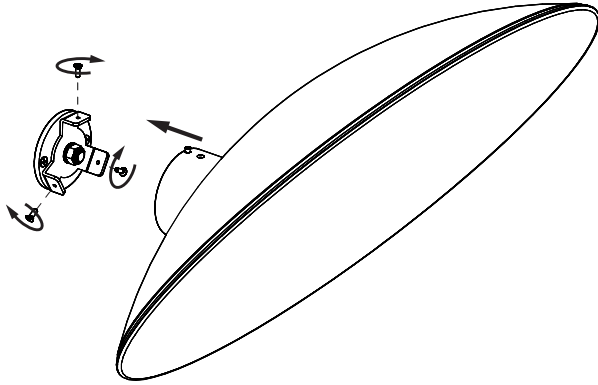

Fixing System Wall | Ceiling included

Formations, as with other architectural features located in the ceiling plane, may obstruct or skew the existing or planned fire sprinkler water distribution pattern, or possibly delay the activation of the fire sprinkler or fire detection system. Designers and installers are advised to consult a protection engineer, NFPA 13, and their local codes for guidance on the proper installation techniques where detection or suppression systems are present.

Rotating Dish

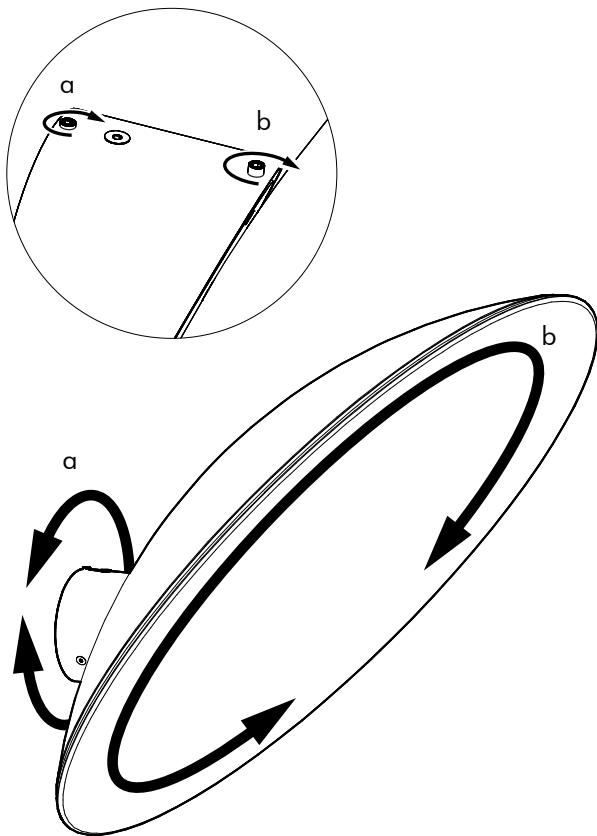

BuzziDish is rotatable in two directions and can be locked with two set screws. Distance between different Dish brackets should be minimal 90 cm | 35.43"

Fabrics

Fabric (45 colors)

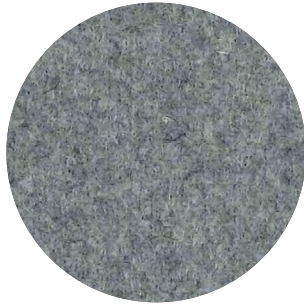

Category A

Composition 70% Recycled Wool, 25% Recycled Polyacryl,
5% Recycled Other Fabrics

Weight 405 g/m² | 11.94 oz/yd²

Abrasion resistance 40.000 Martindale, 50,000 Wyzenbeek

Flammability EU: EN 1021.1/2006 | BS EN 1021.1/2006 (cigarette).
EN 1021.2/2006 | BS EN 1021.2/2006 (match)
USA: CAL TB 117 | ASTM E84 CLASS A

Fastness to light EU: 4 | USA 4

Fastness to rubbing EU: Wet 3-4 | Dry 4-5

Fastness to crocking USA: Wet 5 | Dry 5



Trevira CS+ | CS (47 colors)

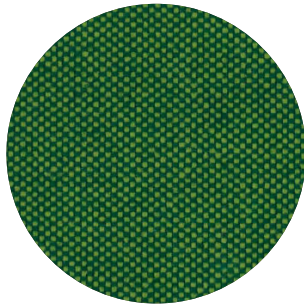

Category A

Weight 420 g/m² | 12.39 oz/yd²

Composition 100% Polyester, Trevira CS

Abrasion resistance 100.000 Martindale, 90,000 Wyzenbeek

Flammability BS 5852 part II: CRIB 5 | BS 7176 Medium Hazard
USA: CAL TB 117 | M1 | B1 | EN 1021/1-2 | C1 |
IMO Res. A652 (16)

Fastness to light EU: 6 | USA 5

Fastness to rubbing EU: Wet 4-5 | Dry 4-5

Fastness to crocking USA: Wet 5 | Dry 5



Revive 1 (25 colors)

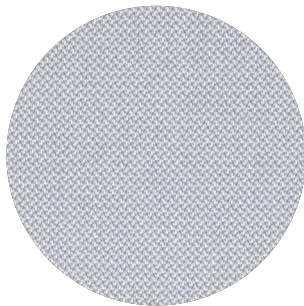

Category A

Composition 100% recycled polyester FR

Weight 430 g/lin.m

Abrasion resistance 60.000 Martindale rubs, EN ISO 12947

Flammability EN 1021-1/2 | DIN 4102 B1 | Önorm B1/Q1
UNI 9175 1IM | US Cal. Tech. Bull. 117
IMO A.652 (16)

Fastness to light Note 5-7, ISO 105-B02

Fastness to rubbing (ISO) dry 5, wet 4-5

Pilling Note 4-5, EN ISO 12945



kvadrat

Clara 2 (24 colors)

kvadrat

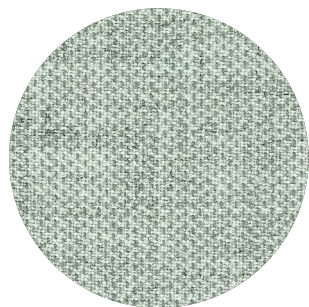

Category B

Composition 92% new wool, 8% nylon

Weight 400 g/lin.m

Abrasion resistance 80.000 Martindale rubs, EN ISO 12947

Flammability EN 1021-1/2 | BS 5852, ignition source 2-3 | DIN 4102 B2
NF D 60 013 | UNI 9175 1IM | US Cal. Tech. Bull. 117, Sec. E
NFPA 260 | IMO A.652(16)

Fastness to light Note 5-7, ISO 105-B02

Fastness to rubbing (ISO) dry 4-5, wet 4

Pilling Note 4, EN ISO 12945



Remix 3 (73 colors)

kvadrat



Category B

Composition 90% new wool, 10% nylon

Weight 415 g/lin.m

Abrasion resistance 100.000 Martindale rubs, EN ISO 12947

Flammability EN 1021-1/2 | BS 5852 part 1
Önorm B1/Q1 | NF D 60 013 | UNI 9175, 1IM
AS/NZS 1530.3 | Cal. Tech. Bull. 117-2013
NFPA 260 | IMO FTP Code 2010:Part 8

Fastness to light Note 5-7, ISO 105-B02

Fastness to rubbing (ISO) dry 4-5, wet 4

Pilling Note 4, EN ISO 12945



Hero 2 (33 colors)

kvadrat

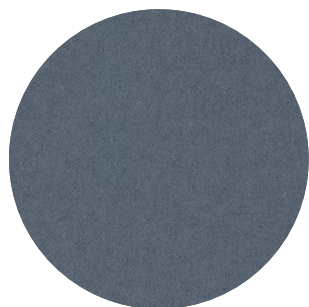

Category C

Composition 97% new wool, 3% nylon

Weight 580 g/lin.m

Abrasion resistance 45.000 Martindale rubs, EN ISO 12947

Flammability EN 1021-1/2 | DIN 4102 B2 | NF D 60 013
UNI 9175 1IM | US Cal. Bull. 117-2013 | NFPA 260
IMO A.652 (16)

Fastness to light Note 5-6, ISO 105-B02

Fastness to rubbing (ISO) dry 4-5, wet 4-5

Pilling Note 3-4, EN ISO 12945



Tonus 4 (47 colors)

kvadrat



Category D

Composition 90% new wool, 10% Helanca

Weight 665 g/lin.m

Abrasion resistance 100.000 Martindale rubs, EN ISO 12947

Flammability EN 1021-1/2 | BS 5852 part 1 | DIN 4102 B2
Önorm B1/Q1 | NF D 60 013 | UNI 9175 1IM
US Cal. Bull. 117-2013 | NFPA 260 | IMO A.652 (16)

Fastness to light Note 5-7, ISO 105-B02

Fastness to rubbing (ISO) dry 3-5, wet 3-5

Pilling Note 3, EN ISO 12945



Memory 2 (20 colors)

kvadrat

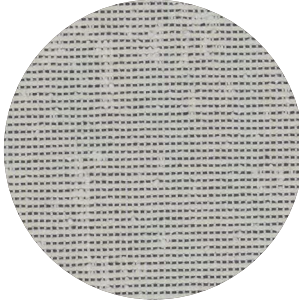

Category E

Composition 100% Trevira CS

Weight 700 g/lin.m

Abrasion resistance

35.000 rubs acc. to the Martindale method, EN ISO 12947

Flammability EN 1021-1/2 | DIN 4102 B1 | Önorm B1/Q1

NF D 60 013 | NF P 92 507 M1 | UNI 9175 11M

UNI 9177 classe 1 | US Cal. Tech. Bull. 117

IMO A.652 (16)

Fastness to light Note 5-8, ISO 105-B02

Fastness to rubbing (ISO) dry 4-5, wet 4-5

Pilling Note 4, EN ISO 12945



Dimensions

BuzziDish

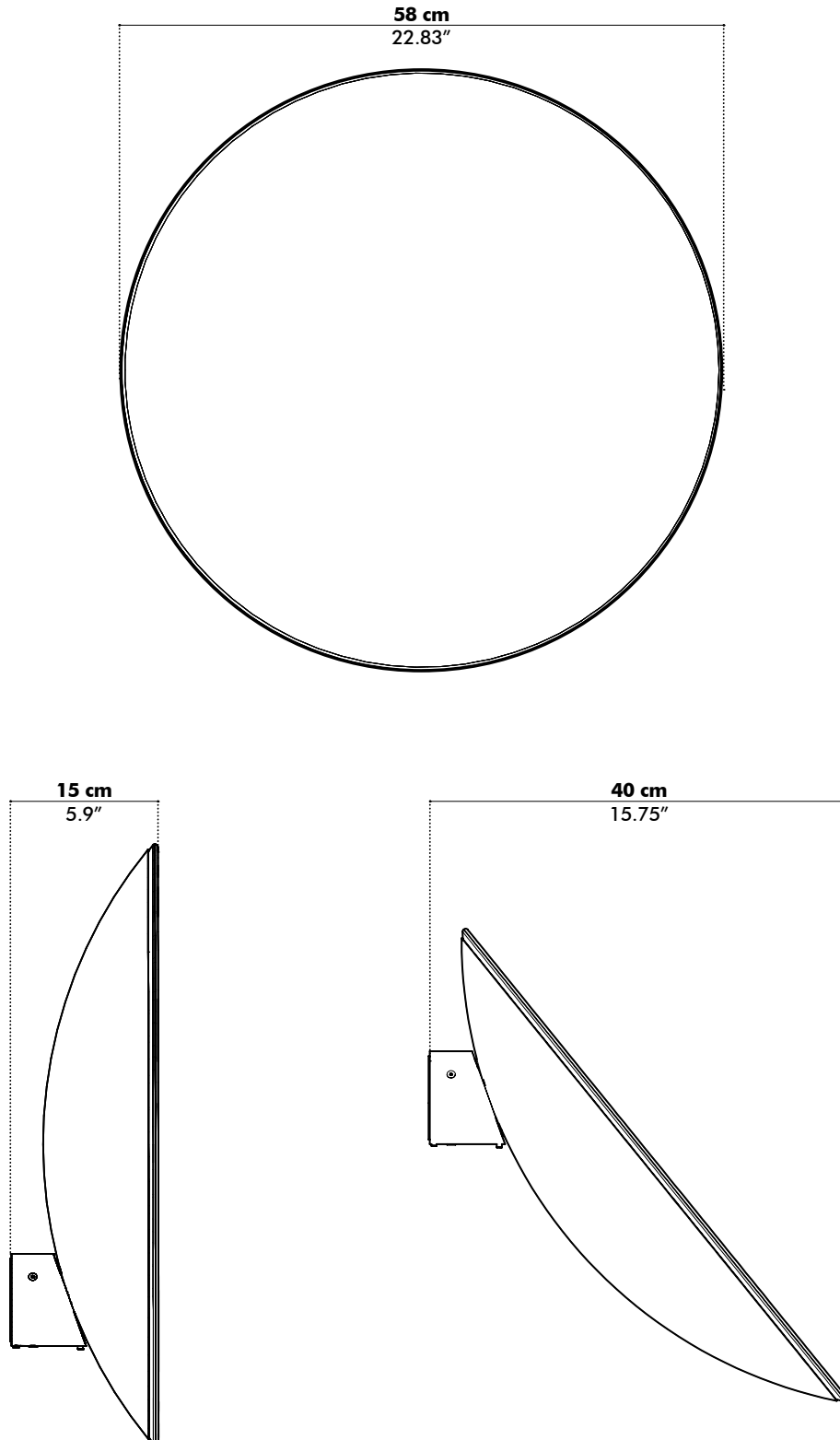

Acoustics

BuzziDish

Equivalent sound absorption area in m² per object

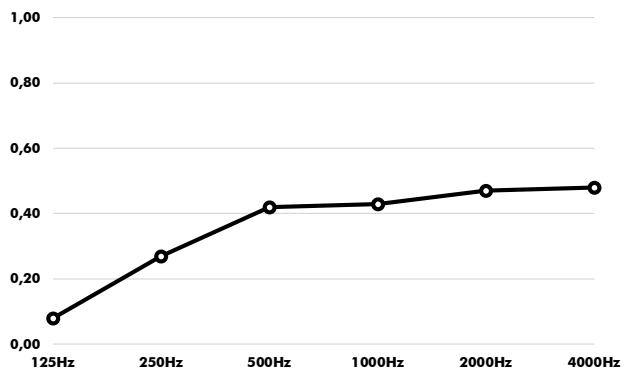

Hz	Aeq/m ²
125	0,08
250	0,27
500	0,42
1000	0,43
2000	0,47
4000	0,48