

# Catifa 46

Design by Lievore Altherr Molina, 2004

## Art. 0372

Sitzelement auf fixem Fußgestell aus Aluminium glänzend oder lackiert, auf selbstbremsenden Rollen (in der gleichen Farbe wie das Gestell). Schale aus Polypropylen, Spiegelpolsterung mit Bezug aus Weichleder, beschichtete Textilien, Stoff oder Kunden



### Abmessungen\*

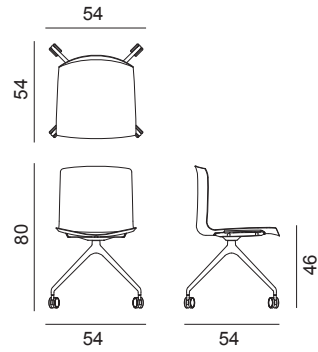

\*2D – 3D CAD files verfügbar zum Download unter [www.arper.com](http://www.arper.com)

### Struktur



### Schale

#### Polypropylen

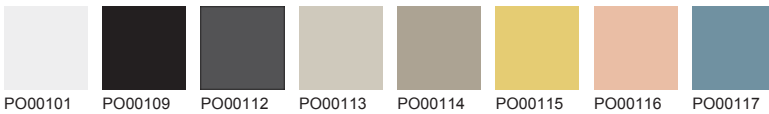

# Catifa 46

Design by Lievore Altherr Molina, 2004



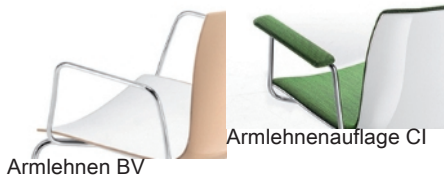

---



---

## LIEFERUNGSAANGABEN

Art.0372

1 pz = 2  - kg 12,9/ m<sup>3</sup> 0,28  
1 pz = 3  - kg 15,28/ m<sup>3</sup> 0,309  
4 pz = 2  - kg 38,24/ m<sup>3</sup> 0,404  
4 pz = 3  - kg 46,38/ m<sup>3</sup> 0,44

---

## TECHNISCHE DATEN

Art.0372

COL Lederverbrauch m<sup>2</sup> 0.94  
H 140 cm. COM Stoffverbrauch m 0.65

---

---

## FEUERFESTIGKEITSTEST

---

PRODUKTZERTIFIZIERUNG



# Catifa 46

Design by Lievore Altherr Molina, 2004

---

## FITZGLEITER

STANDARD



Hartboden



Hartboden



Hartboden